

## ① External Dimensions

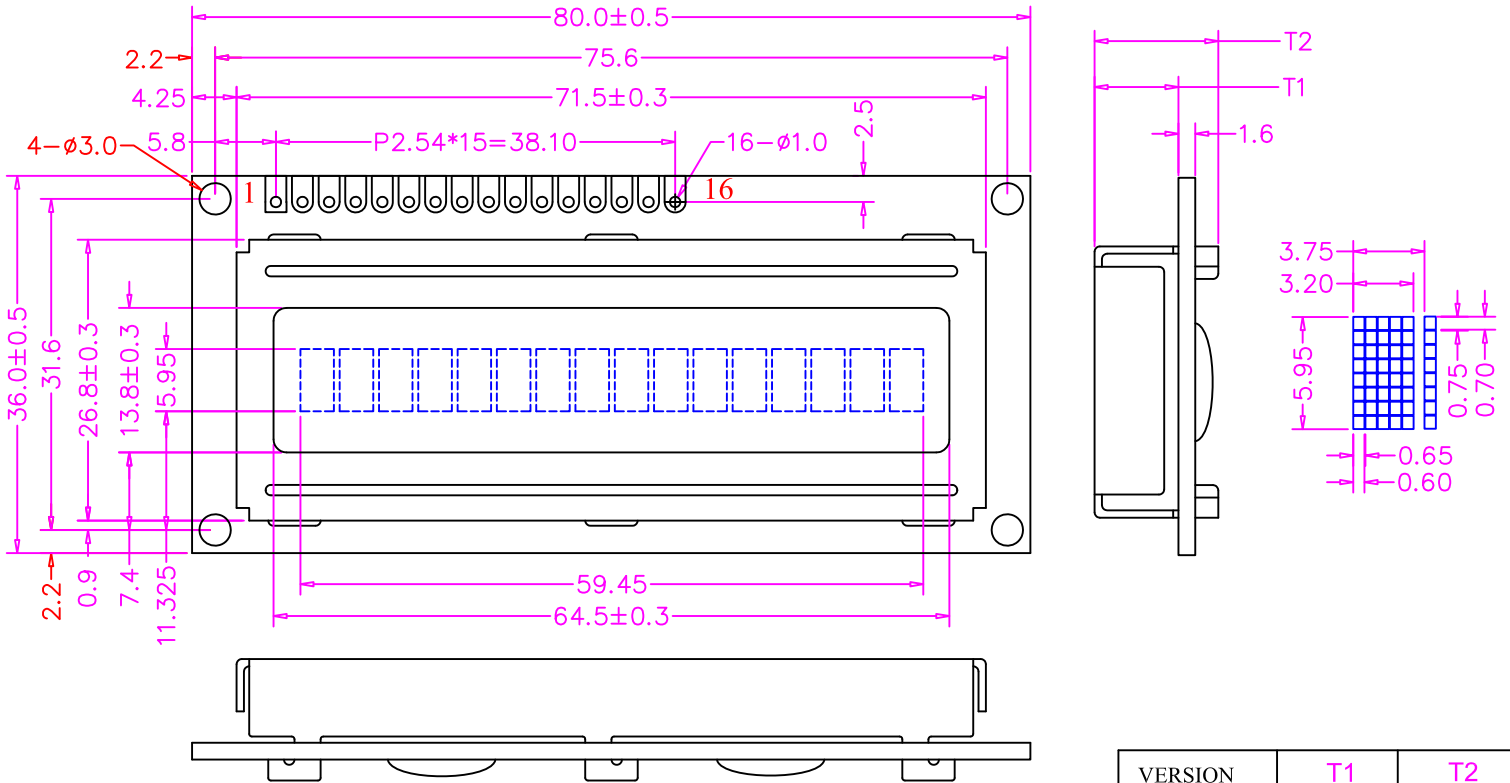

VERSION	T1	T2
LED BackLight	8.0 ± 0.3	MAX 12.5
No BackLight	4.6 ± 0.3	MAX 9.2

## ② Electrical Characteristics

ITEM	Symbol	Condition	Min.	Typ.	Max.	Unit
Operating Voltage	VDD	Ta=25° C		5.0		V
Operating Voltage for LCD	VDD-V0	Ta=25° C		4.5		V
Supply Current	IDD	VDD=5.0V		1.0		mA

## ③ Pin Configuration

Pin	Symbol	Level	Description
1	VSS	0V	Power GND
2	VDD	+5V	Supply Voltage for logical circuit
3	V0	-	Voltage For LCD Panel Drive
4	RS	H/L	Register select input pin
5	R/W	H/L	Read/Write Select
6	E	H, H→L	Read/write enable
7	DB0	H/L	Data Bus
8	DB1	H/L	
9	DB2	H/L	
10	DB3	H/L	
11	DB4	H/L	
12	DB5	H/L	
13	DB6	H/L	
14	DB7	H/L	
15	BLA	+5V	LED BACKLIGHT +
16	BLK	0V	LED BACKLIGHT -

## ④ Block Diagram

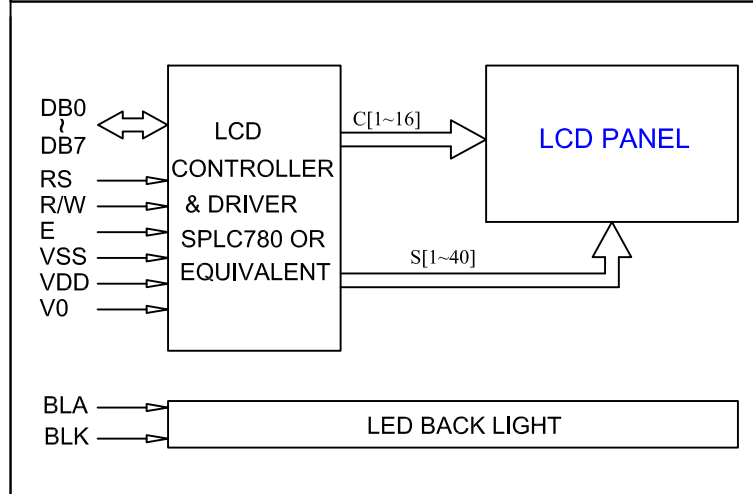

## ⑤ Example Power Supply

